

T24 VECTOR PANEL
LAY-IN
SYSTEM

T24 VECTOR PANEL LAY-IN SYSTEM

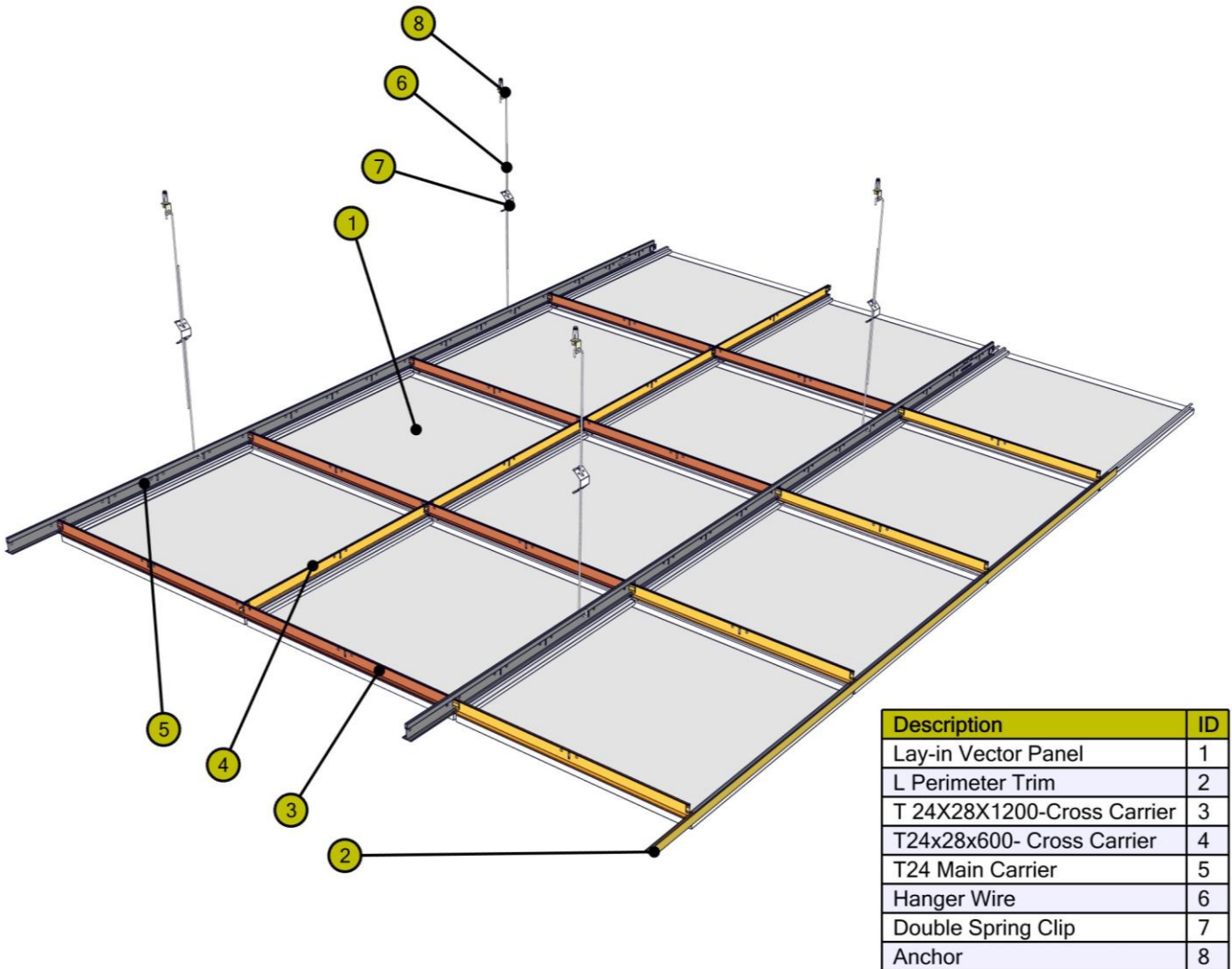

1. T-24 carrier system profiles are designed specially with their locking systems to serve for your needs at many suspended ceilings like mineral fiber, gypsum ceilings glass wool.
2. T-24 Carrier system profiles have the capacity to carry heavy load. Also the look provided by smooth and symmetrical lines contributes to building's aesthetic.
3. This system is preferred, when there is a need to reach soffit area so often.
4. It is also possible to have seismic system by using Butem T24 seismic profile.

DETAIL VIEW

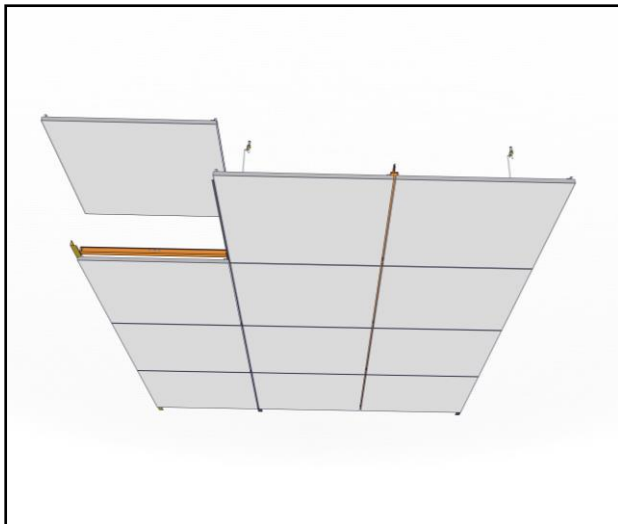
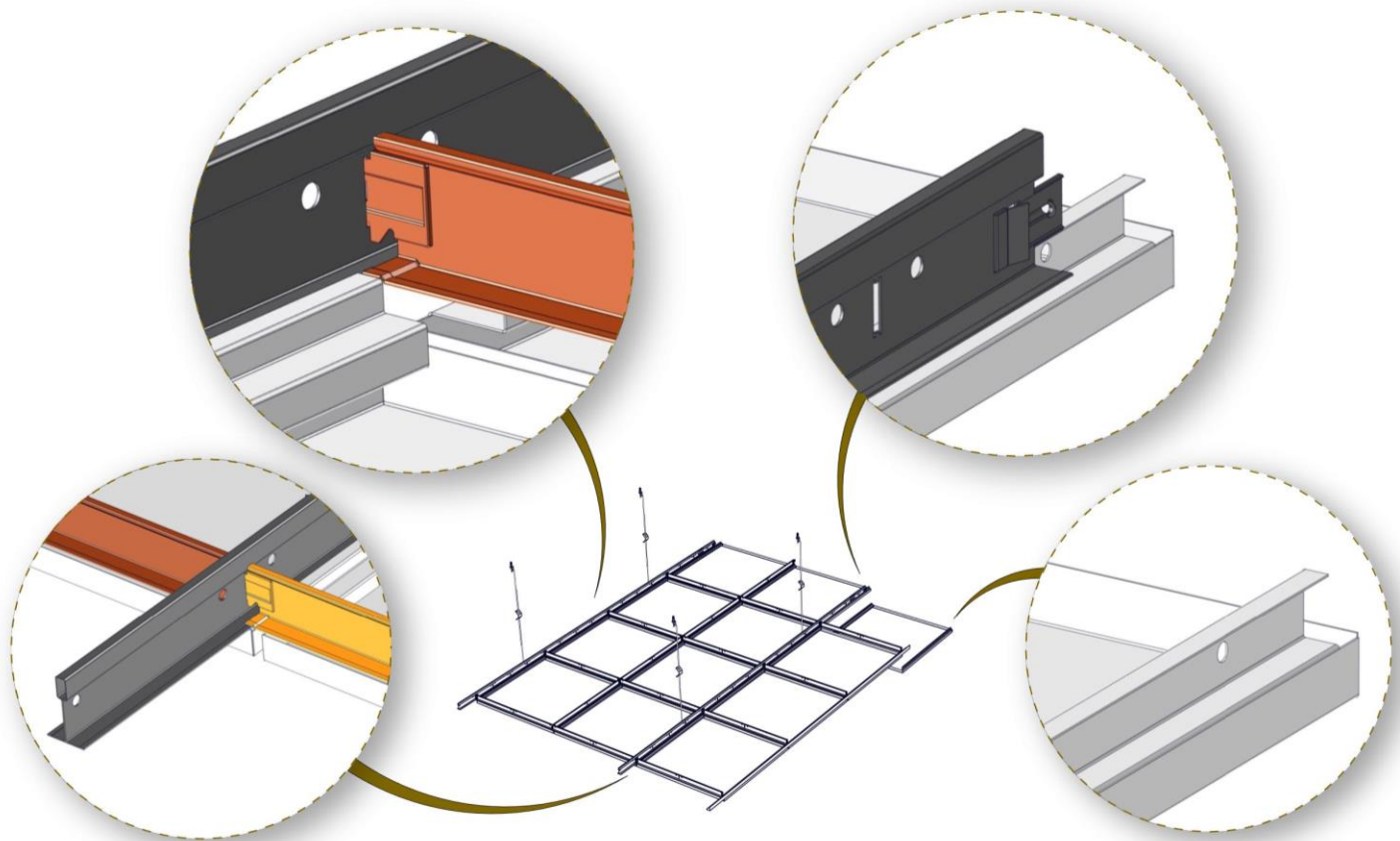

MATERIAL OPTIONS

Galvanized Steel/Aluminum / Stainless Steel

ACOUSTIC

High acoustic performance with acoustic fleece up to α_w : 1,00

HUMIDITY

Galvanize panel: 90% RH

Aluminum panel: 100 % RH

LIGHT REFLECTION

Straight Panel: 9010 Painted % 86

Perforated Panel : 9010 Painted % 72

HYGIENE

High performance in Blocking bacterial formation on panel surfaces by applying anti-microbial paint.

PAINT

Prior to paint. Sensitive surface cleaning and phosphate coverage is applied. 60 minimum micron powder paint is sprayed by electrostatic system through 6 robots and cooked in a 180 meters long oven. The entire painting process takes place automatically by computer control.

ELEMENT SPECIFICATION

1. Vector Panel

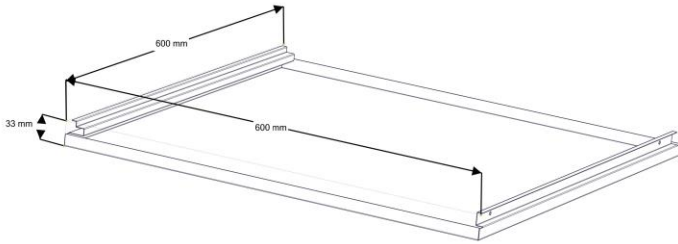

T : 0,50 mm Galvanized Steel / 0,60 mm Aluminum
0,50 mm Stainless Steel

2. L Perimeter Trim

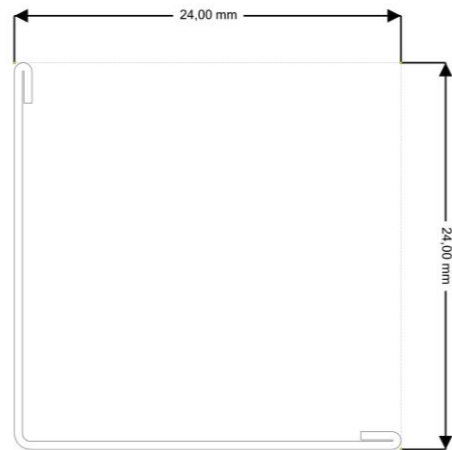

T : 0,5 mm Pre-Paint Steel
W : 24 mm **H** : 24 mm **L** : Up to 3000 mm

3. T24 Cross Carrier 1200 mm

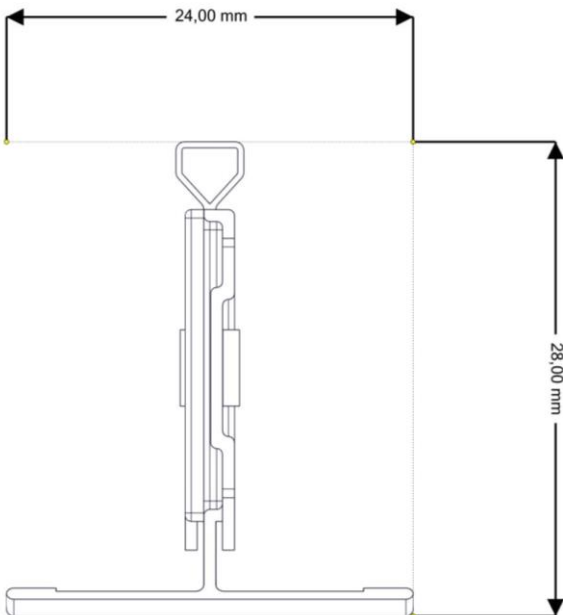

T : 0,30 mm Galvanized Steel
W : 24 mm **H** : 28 mm **L** : 1200 mm

4. T24 Cross Carrier 600 mm

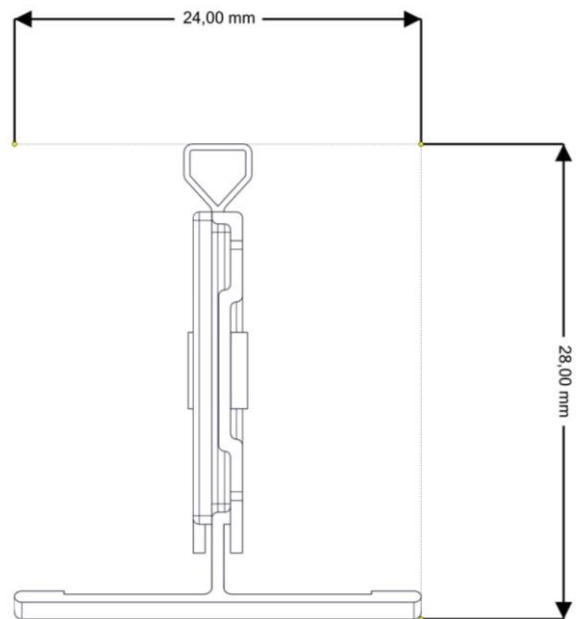

T : 0,30 mm Galvanized Steel
W : 24 mm **H** : 28 mm **L** : 600 mm

5. T24 Main Carrier 3600 mm

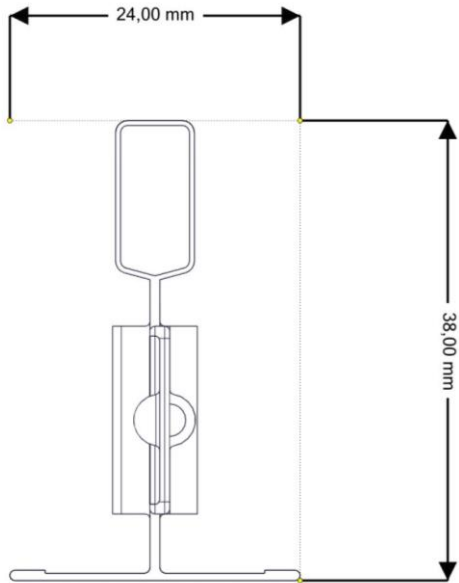

T : 0,35 mm Galvanized Steel
W : 24 mm **H** : 38 mm **L** : 3600 mm

6. Hanger Wire

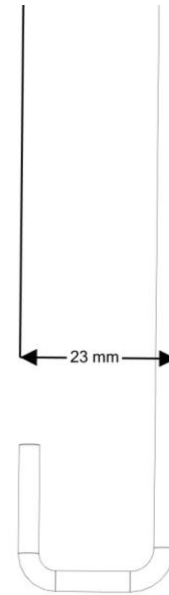

T : Ø 4 mm Galvanized Steel
L : Max 2000 mm

7. Double Spring Clip

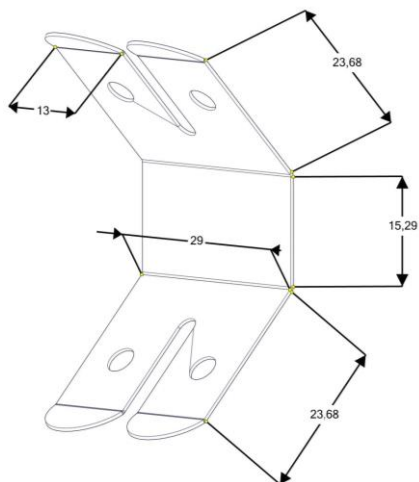

T : 0,50 mm Spring Steel

8. Anchor

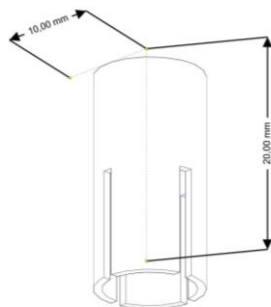
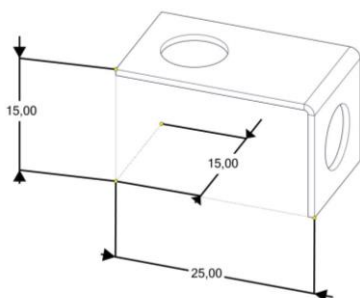
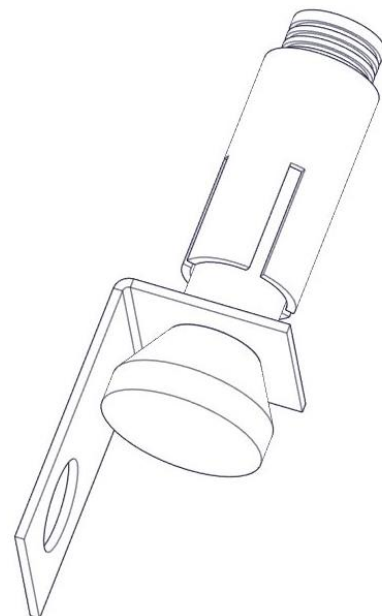

T : 0,8 mm / 2 mm / Ø 8 mm Galvanized Steel

DETAIL SECTION

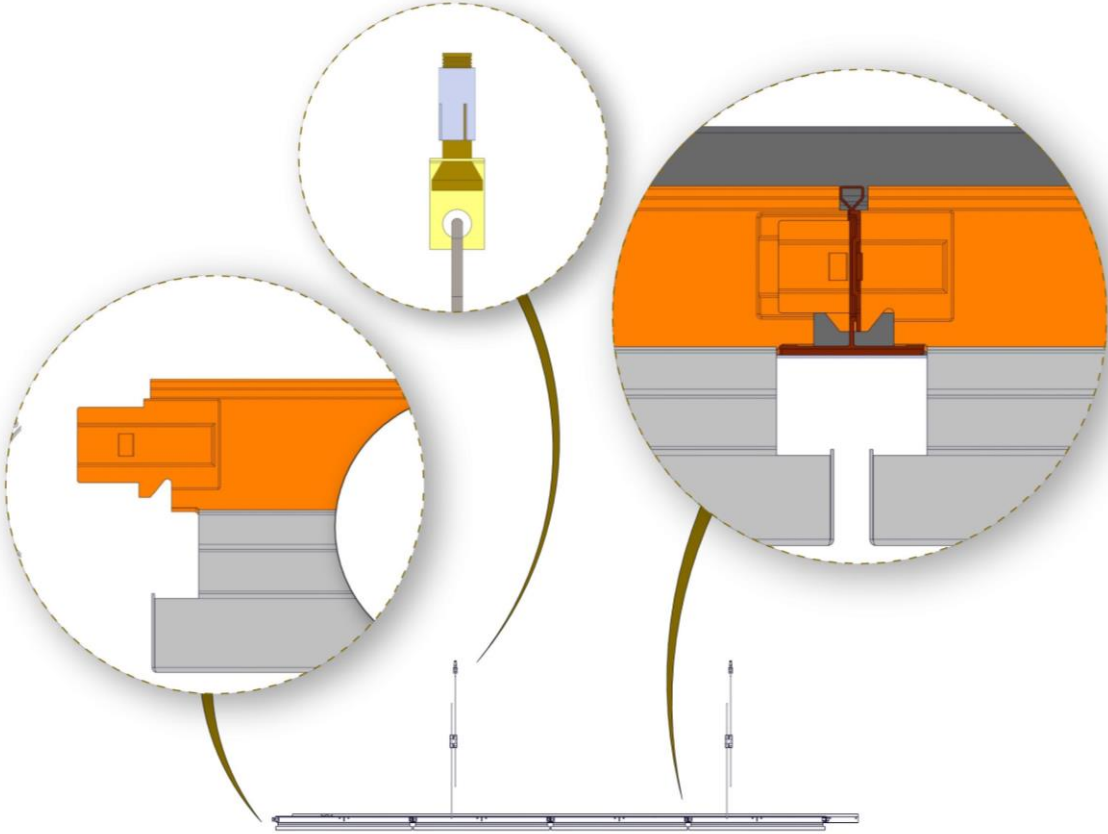
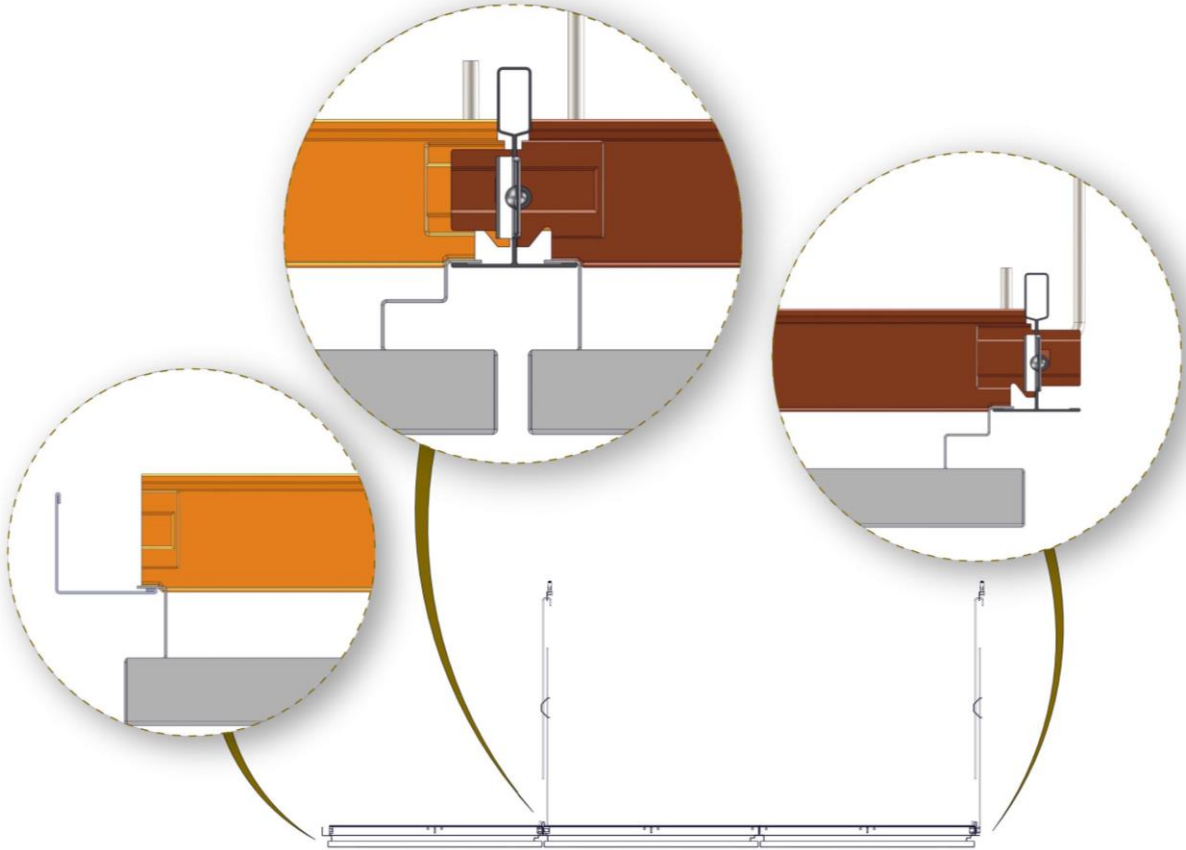

ASSEMBLY TECHNIQUE

STEP 1.

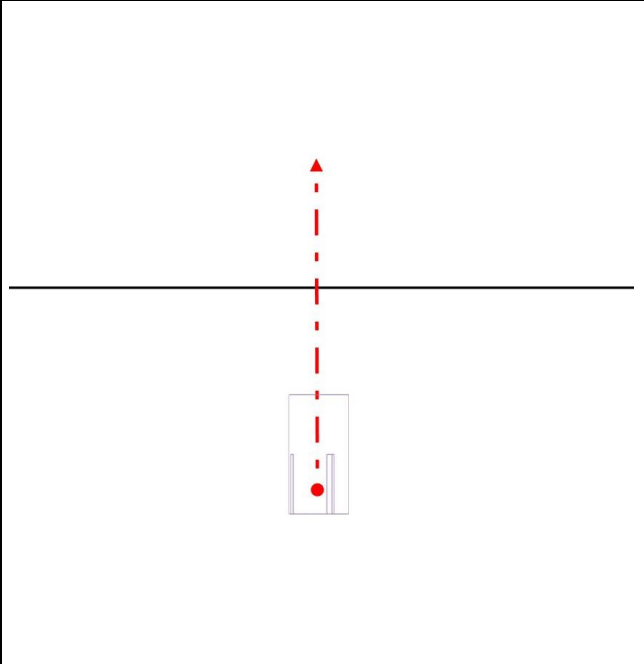

STEP 2.

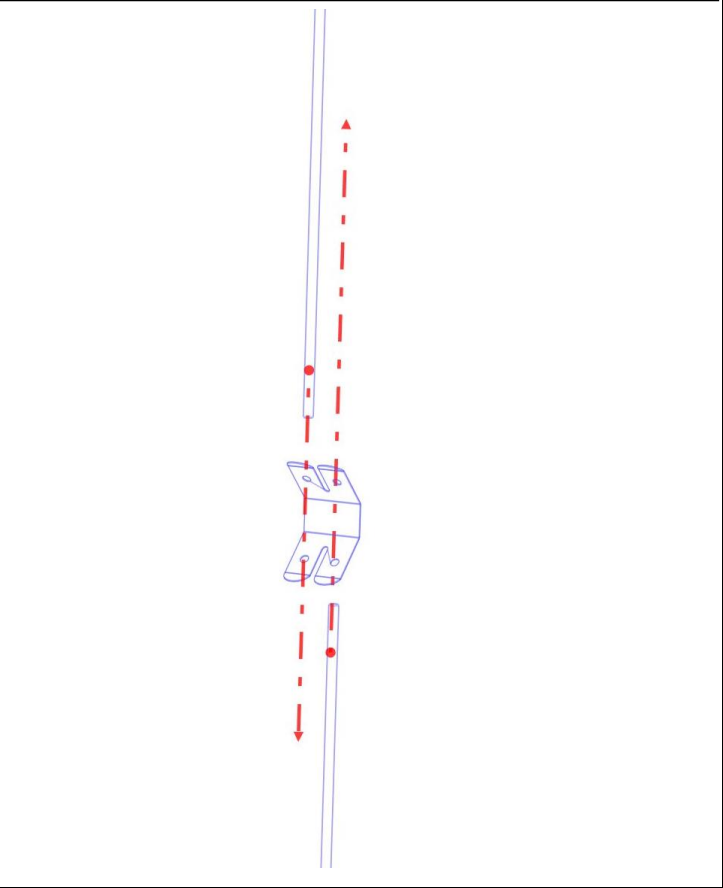
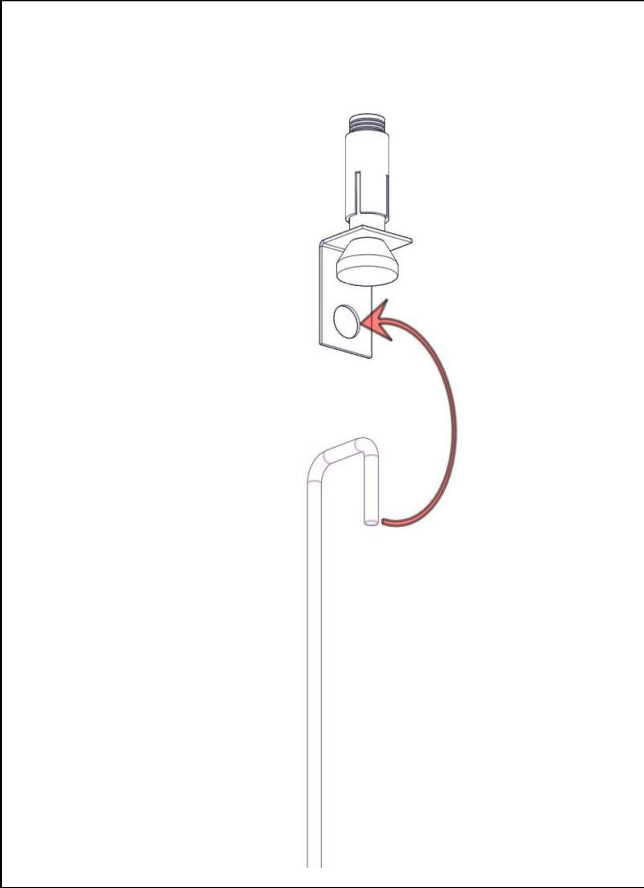
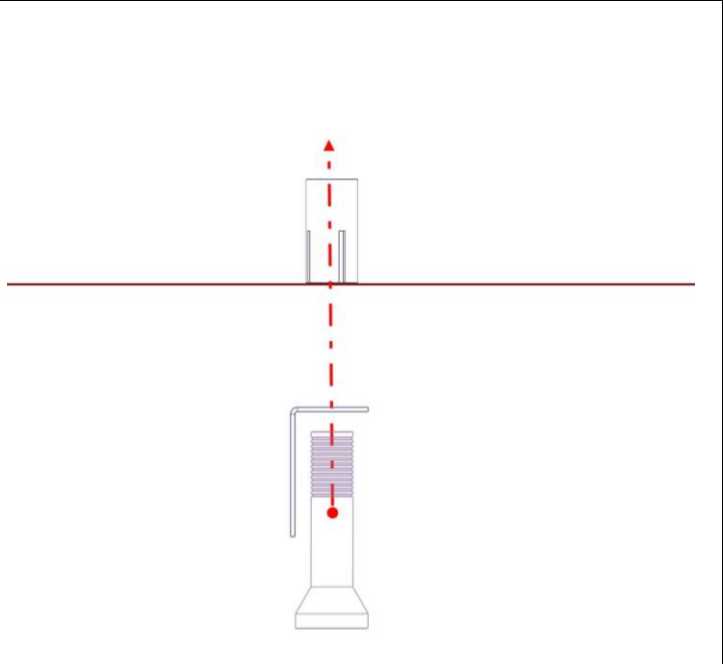

STEP 3.

STEP 4.

STEP 5.

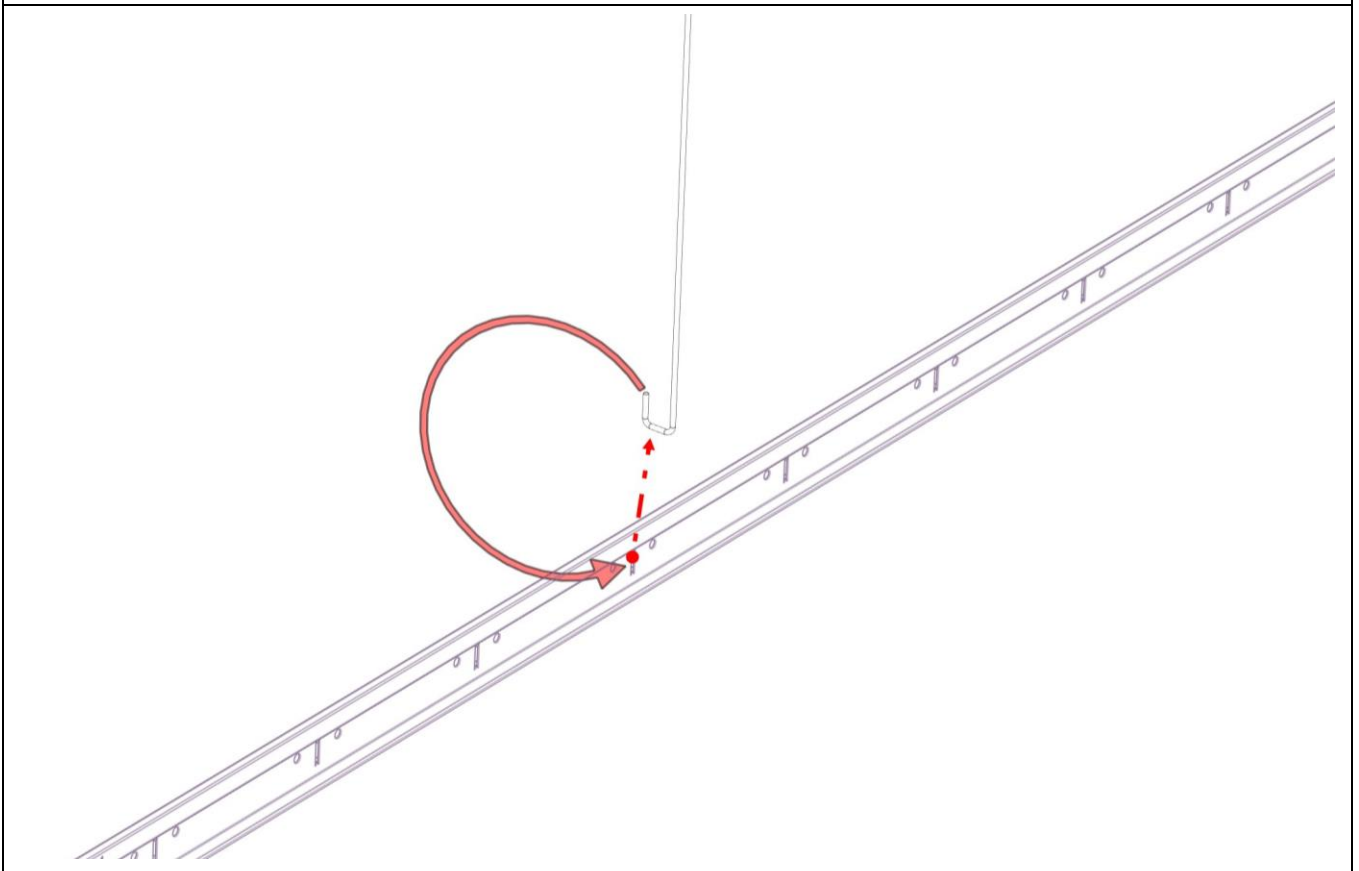
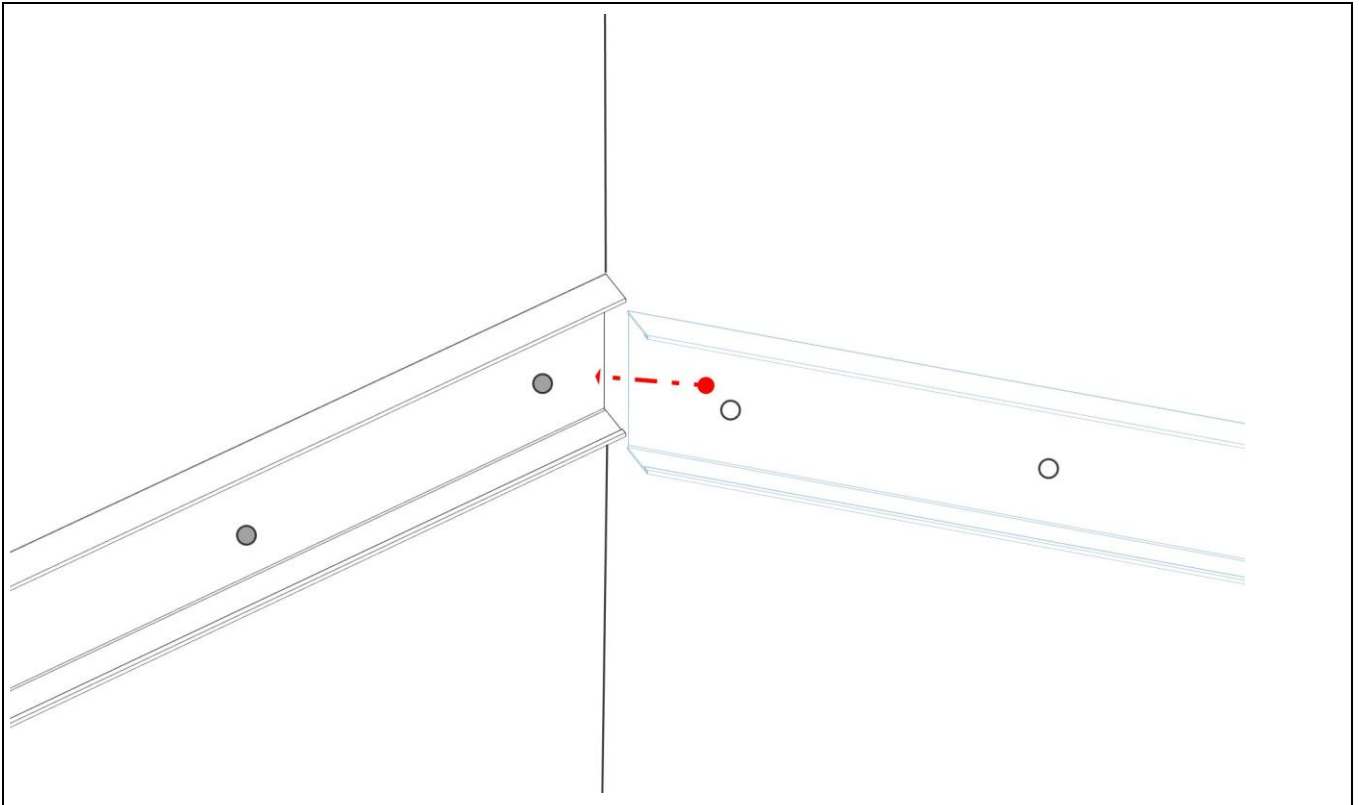

STEP 6.

STEP 7.

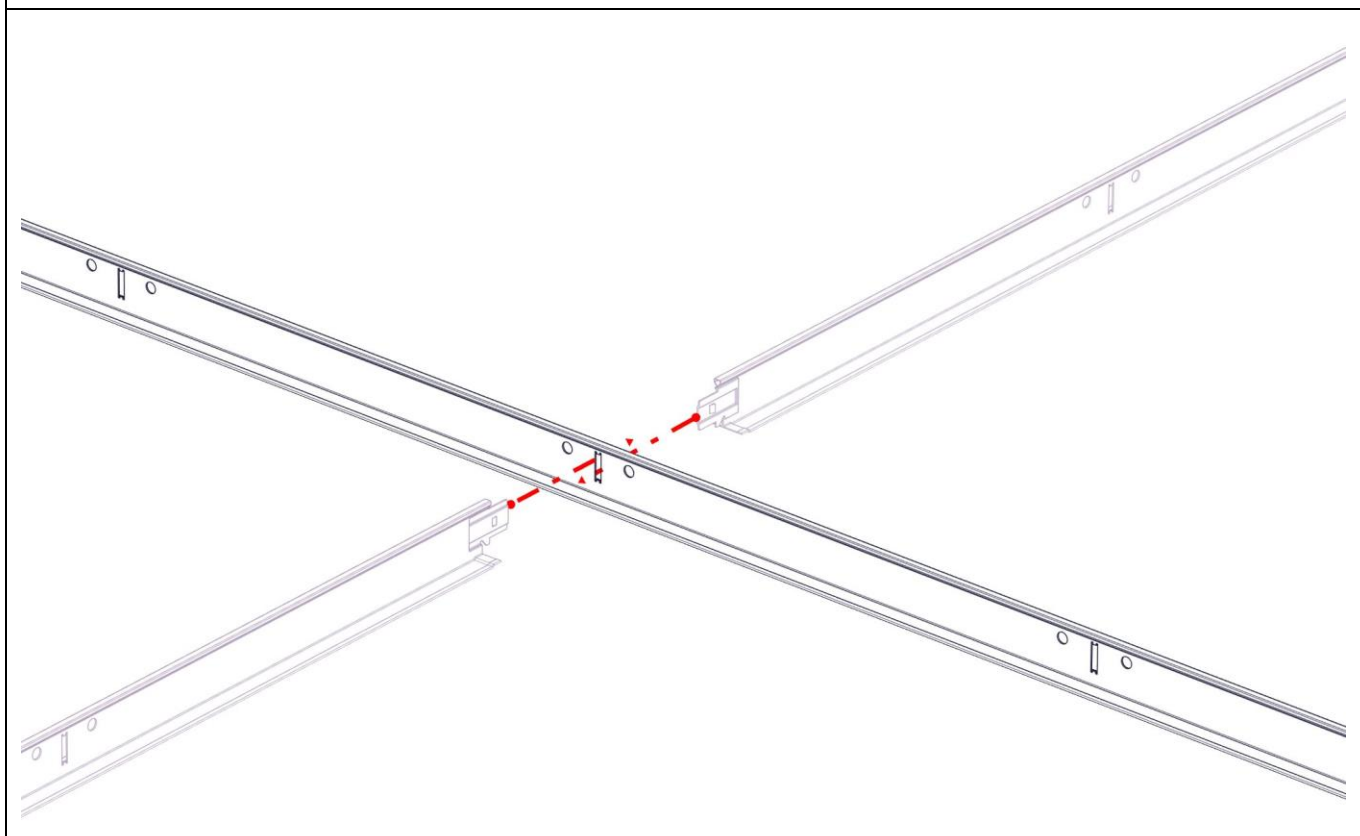
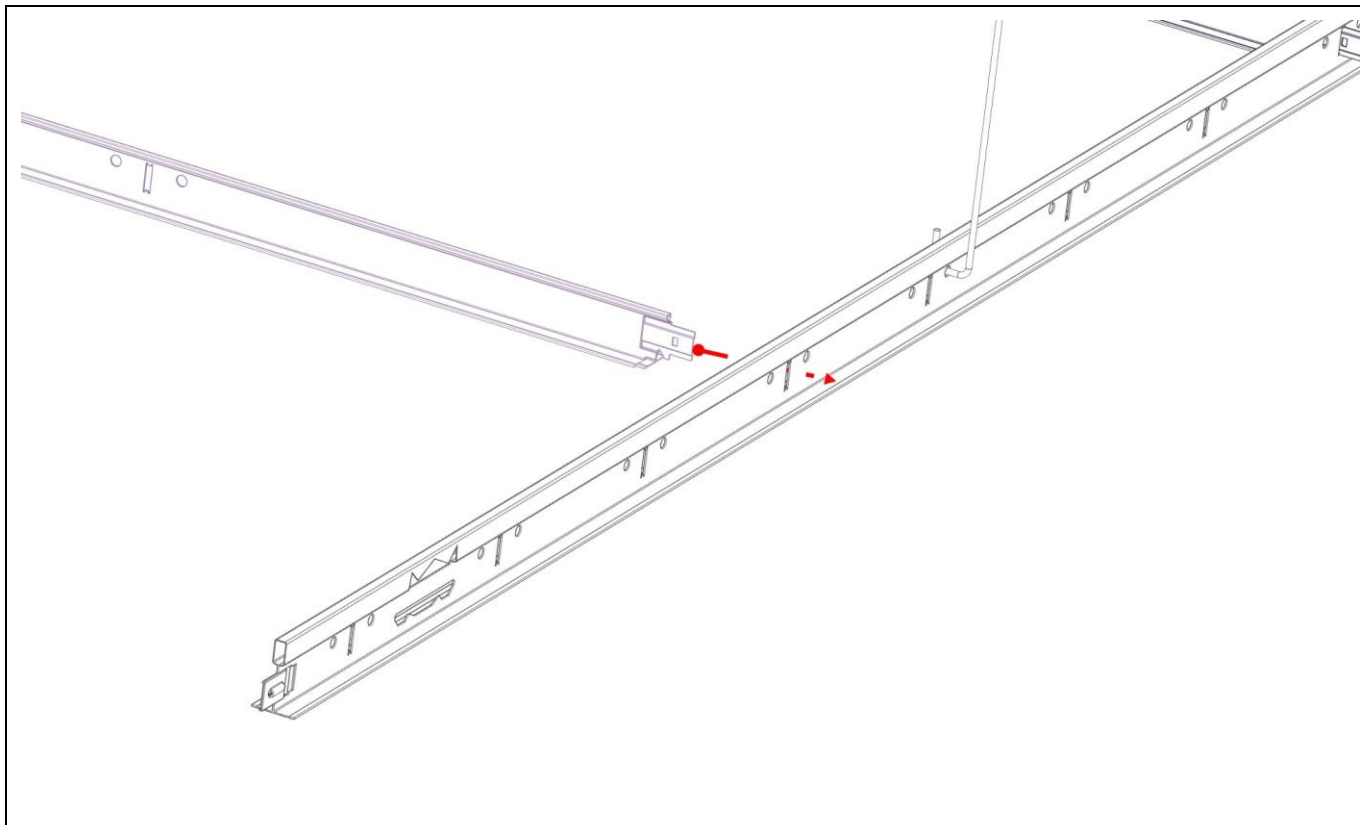

STEP 8.

STEP 9.

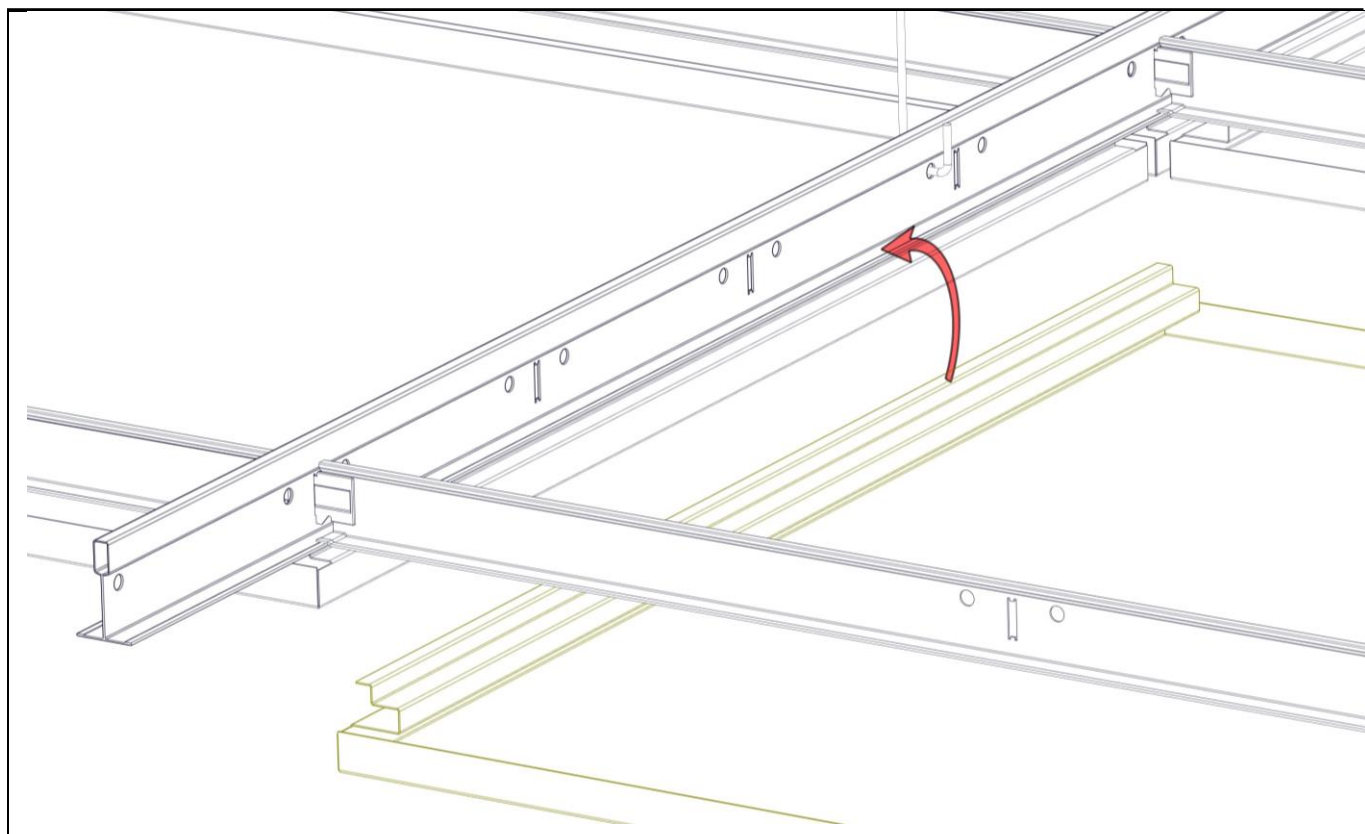

Declaration of Performance

No:A-INT.PD20171001-01



1.Uniquade identification code of the product-type:	Metal Ceiling Systems
2.Type, batch or serial number or any other element allowing identification of the construction product as required pursuant to Article 11 (4):	Product Type, Order/Batch Nr.
3.Intended use or uses of the construction product, in accordance with the applicable harmonized technical specification, as foreseen by the manufacturer:	Internally, to produce an installed suspended ceiling
5.Where applicable, name and contact address of the authorized representative whose mandate covers the tasks specified in Article 12 (2):	Not Applicable
6.System or systems of assessment and verification of constancy of performance of the construction product as set out in Annex V:	Systems 3
7.In case of the declaration of performance concerning a construction product covered by a harmonized standard:	(a)The manufacturer carrying out factory production control; (b) Turkish Standards Institution (TSE) /Notified Body No:1783 issued the Reaction to Fire classification report (Report No:TSE-19.01.2017-170050) according to TS EN 13501-1+A1:2013-04 as the notified testing laboratory (based on sampling carried out by the manufacturer).
8.In case of the declaration of performance concerning a construction product for which a European Technical Assessment has been issued:	Not Applicable

Declaration of Performance

No:A-INT.PD20171001-01



9.Declared Performance

- (a) Column 1 shall contain the list of essential characteristics as determined in the harmonized technical specifications for the intended use or uses indicated in point 3 above.
- (b) For each essential characteristic listed in column 1 and in compliance with the requirements of Article 6, Column 2 shall contain the declared performance, expressed by level or class, or in a description, related to the corresponding essential characteristics. The letters 'NPD' (No Performance Determined) shall be indicated where no performance is declared.
- (c) For each essential characteristic listed in column 1, column 3 shall contain:
- I-Dated reference of the corresponding harmonized standard and, where relevant, the reference number of the Specific or Appropriate Technical Documentation used; or
 - II-Dated reference of the corresponding European Assessment Document where available and reference number of the European Technical Assessment used.

Essential Characteristics	Performance	Harmonized Technical Specification
Reaction To fire	A2-s1, d0	TS EN 13964:2014-04 + TS EN13501-1+A1:2010
Release of Dangerous Substances	No Content	TS EN 13964:2014-04 + TS EN13501-1+A1:2010
Flexural Tensile Strength	NPD	TS EN 13964:2014-04 + TS EN13501-1+A1:2010
Thermal Conductivity	NPD	TS EN 13964:2014-04 + TS EN13501-1+A1:2010
Durability	Corrosion Class B	TS EN 13964:2014-04 + TS EN13501-1+A1:2010
Sound Absorption Single Value a_w	See Table Below	TS EN 13964:2014-04 + TS EN13501-1+A1:2010

Sound Absorption Single Value a_w	Perforation Types		
	Ø1,5 mm	Ø1,8 mm	Ø2,5 mm
JM 60	-	0,35	0,35
Royalin R6/60	0,60		
JM 60 Double	0,45		
JM60 with 25 mm 50 kg/m ³ rockwool	1,00		

10.The performance of the product identified in point 1 and 2 is in conformity with he declared performance in point 9.

This declaration of performance is issued under the sole responsibility of the manufacturer identified in point 4.